

PROXIMITY SERIES: InfiniTube™ In-Line Assembly™ FM-Series

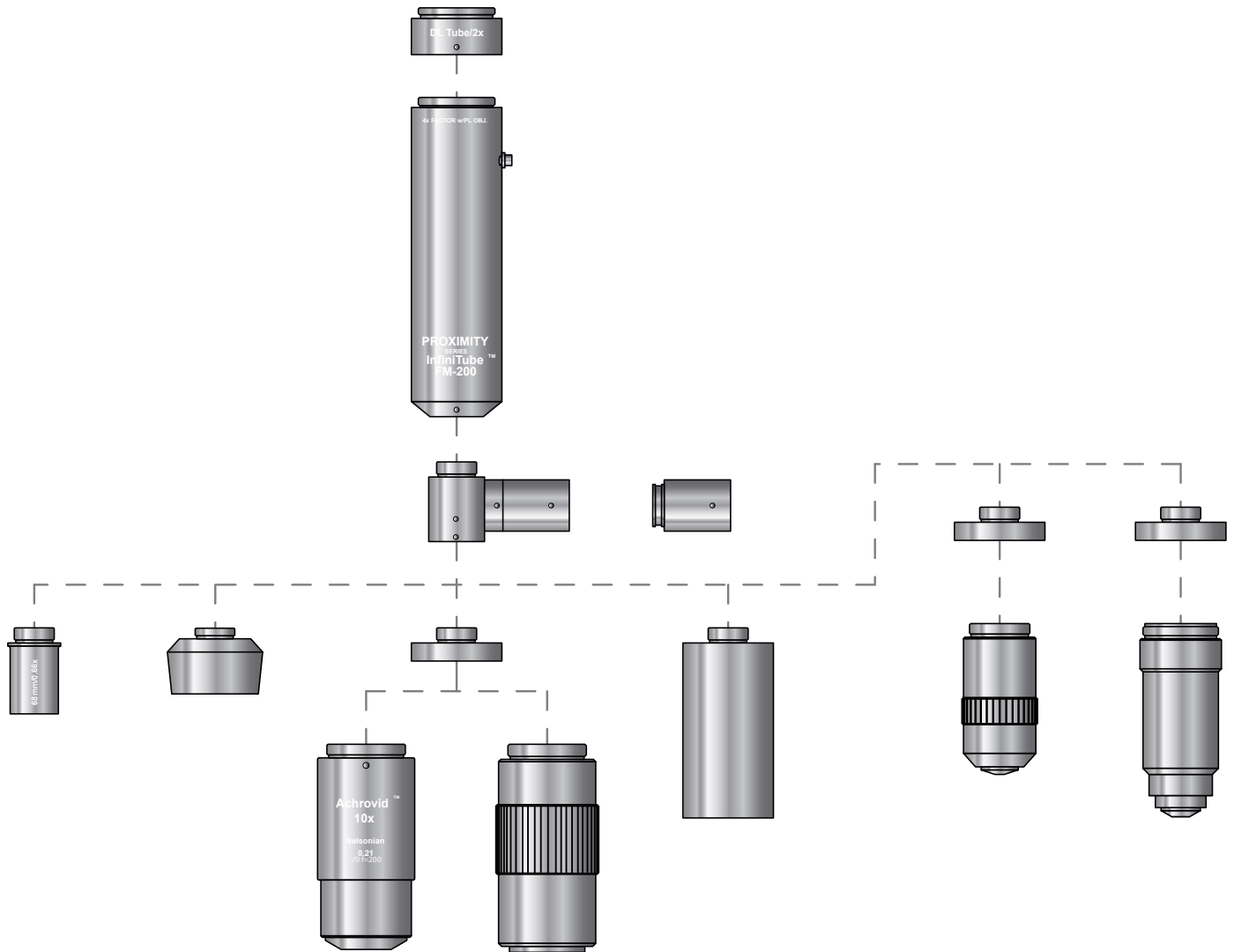

PL-SERIES OBJECTIVES OPTICAL DATA

PL-Series Objectives		PL-14	PL-18	PL-35	PL-44	PL-55	PL-68	PL-94	PL/FD-195	PL/FD-295	PL/FD-390
Data	WD mm	14	18	35	44	55	68	94	195	295	390
	NA	0.200	0.156	0.098	0.085	0.083	0.073	0.055	0.030	0.020	0.015
	Resolution (lines/mm)	600	468	293	255	250	220	165	90	60	45
	Resolution (microns)	1.7	2.1	3.4	3.9	4.0	4.5	6.1	11.1	16.7	22.2
	DOF mm	0.043	0.022	0.058	0.076	0.079	0.102	0.182	0.611	1.375	2.44

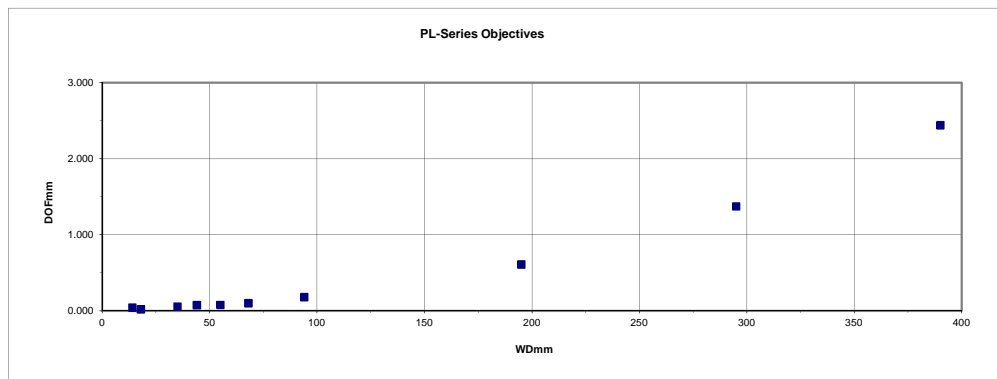
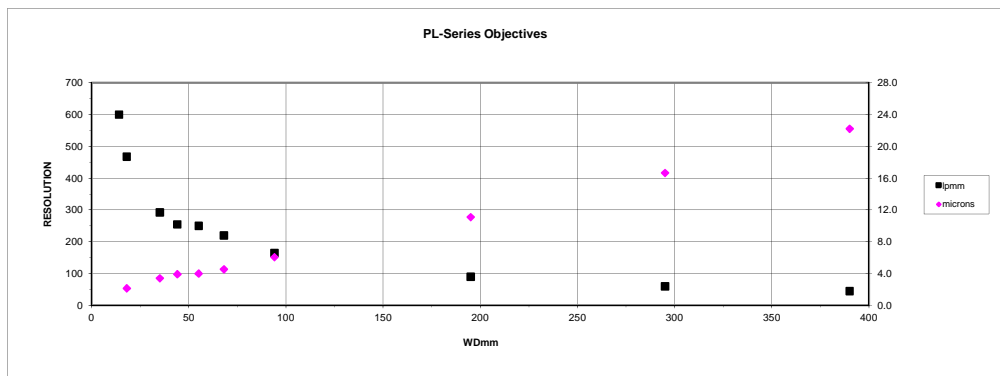
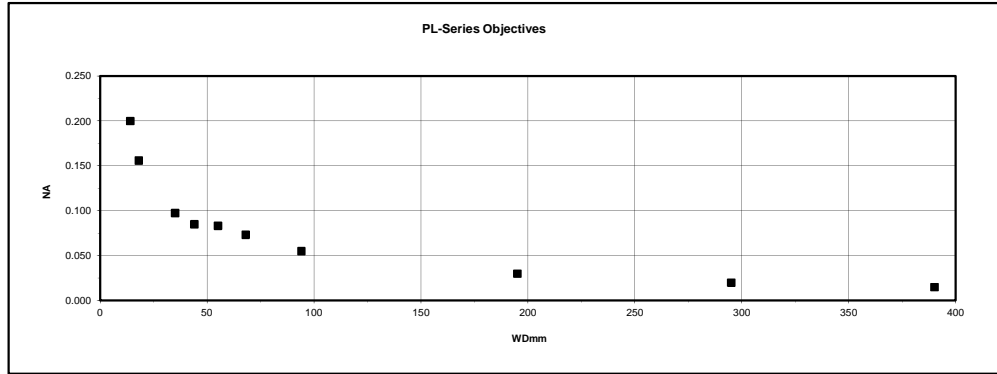

INFINITUBE FM-50

PL-Series Objectives		PL-14	PL-18	PL-35	PL-44	PL-55	PL-68	PL-94	PL/FD-195	PL/FD-295	PL/FD-390
InfiniTube FM-50	WD mm	14	18	35	44	55	68	94	195	295	390
	Mag	2.50	2.00	1.25	1.00	0.83	0.66	0.50	0.25	0.167	0.125
	FOV 1/2"	2.6	3.2	5.1	6.4	7.7	9.7	12.8	25.6	38.3	51.2
	FOV 1/3"	1.9	2.4	3.8	4.8	5.8	7.3	9.6	19.2	28.7	38.4
2x Amplifier	WD mm	14	18	35	44	55	68	94	195	295	390
	Mag	5.00	4.00	2.50	2.00	1.66	1.32	1.00	0.50	0.33	0.25
	FOV 1/2"	1.3	1.6	2.6	3.2	3.9	4.8	6.4	12.8	19.2	25.6
	FOV 1/3"	1.0	1.2	1.9	2.4	2.9	3.6	4.8	9.6	14.4	19.2

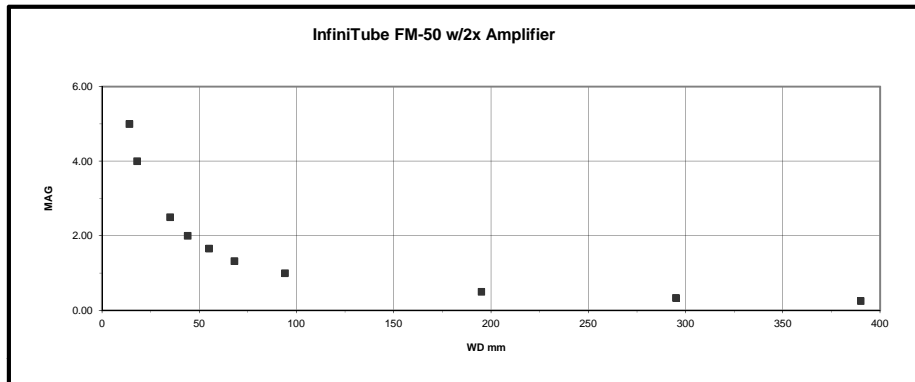
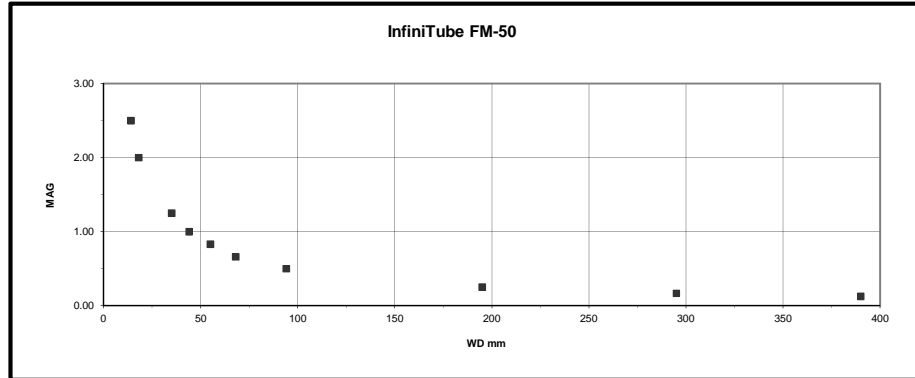

INFINITUBE FM-75

PL-Series Objectives		PL-14	PL-18	PL-35	PL-44	PL-55	PL-68	PL-94	PL/FD-195	PL/FD-295	PL/FD-390
InfiniTube FM-75	WD mm	14	18	35	44	55	68	94	195	295	390
	Mag	3.75	3.00	1.875	1.50	1.25	1.00	0.75	0.375	0.25	0.188
	FOV 1/2"	1.7	2.1	3.4	4.3	5.1	6.4	8.5	17.1	25.6	34.0
	FOV 1/3"	1.3	1.6	2.6	3.2	3.8	4.8	6.4	12.8	19.2	25.5
2x Amplifier	WD mm	14	18	35	44	55	68	94	195	295	390
	Mag	7.5	6.00	3.75	3.00	2.50	2.00	1.50	0.75	0.50	0.38
	FOV 1/2"	0.9	1.1	1.7	2.1	2.6	3.2	4.3	8.5	12.8	17.0
	FOV 1/3"	0.6	0.8	1.3	1.6	1.9	2.4	3.2	6.4	9.6	12.8

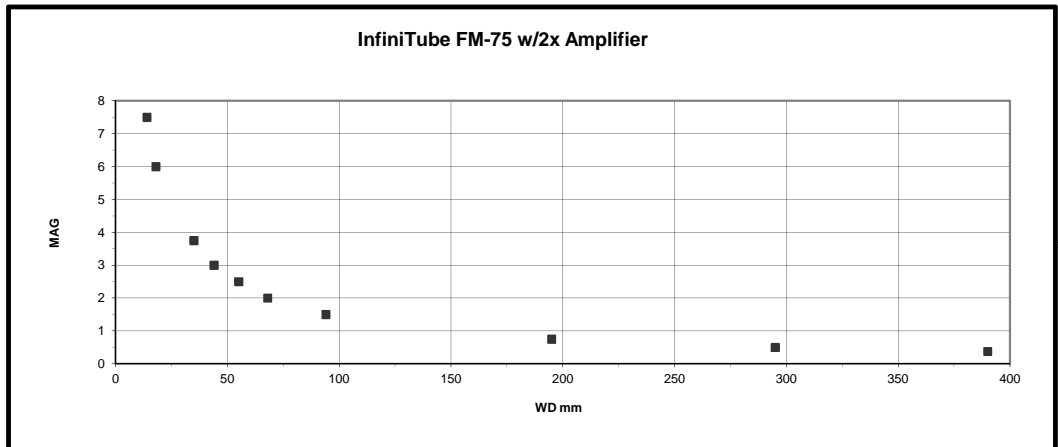
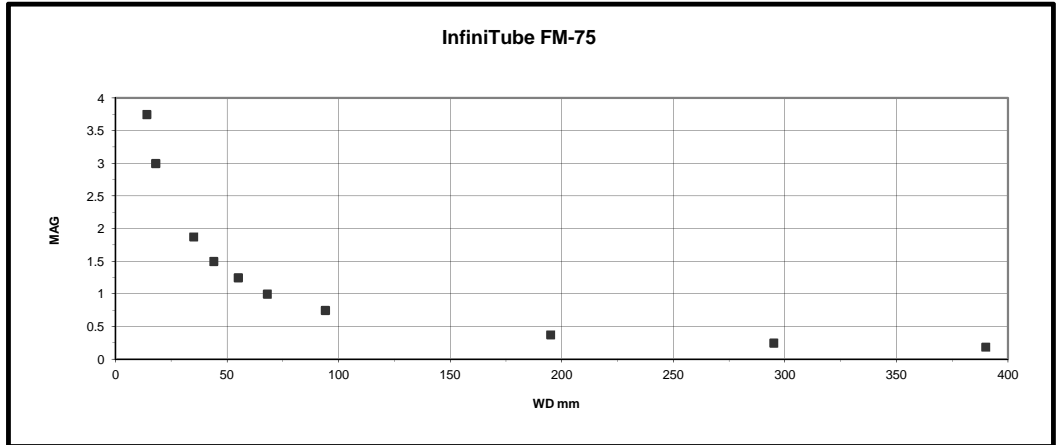

INFINITUBE FM-100

PL-Series Objectives		PL-14	PL-18	PL-35	PL-44	PL-55	PL-68	PL-94	PL/FD-195	PL/FD-295	PL/FD-390
InfiniTube FM-100	WD mm	14	18	35	44	55	68	94	195	295	390
	Mag	5.00	4.00	2.50	2.00	1.65	1.33	1.00	0.50	0.33	0.25
	FOV 1/2"	1.3	1.6	2.6	3.2	3.9	4.8	6.4	12.8	19.4	25.6
	FOV 1/3"	1.0	1.2	1.9	2.4	2.9	3.6	4.8	9.6	14.5	19.2
2x Amplifier	WD mm	14	18	35	44	55	68	94	195	295	390
	Mag	10.00	8.00	5.00	4.00	3.30	2.66	2.00	1.00	0.66	0.50
	FOV 1/2"	0.6	0.8	1.3	1.6	1.9	2.4	3.2	6.4	9.7	12.8
	FOV 1/3"	0.5	0.6	1.0	1.2	1.5	1.8	2.4	4.8	7.3	9.6

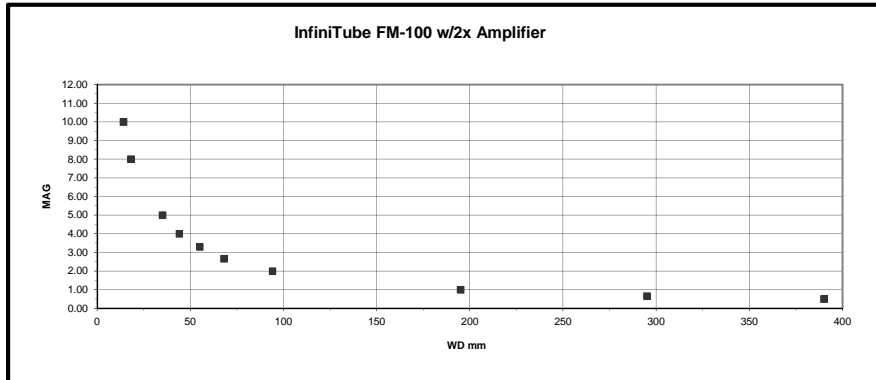
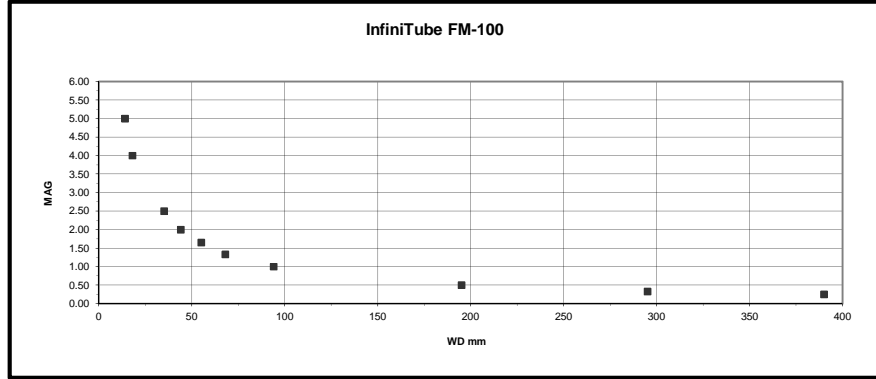

INFINITUBE FM-200

PL-Series Objectives		PL-14	PL-18	PL-35	PL-44	PL-55	PL-68	PL-94	PL/FD-195	PL/FD-295	PL/FD-390
InfiniTube FM-100	WD mm	14	18	35	44	55	68	94	195	295	390
	Mag	10.00	8.00	5.00	4.00	3.30	2.66	2.00	1.00	0.66	0.5
	FOV 1/2"	0.6	0.8	1.3	1.6	1.9	2.4	3.2	6.4	9.7	12.8
	FOV 1/3"	0.5	0.6	1.0	1.2	1.5	1.8	2.4	4.8	7.3	9.6
2x Amplifier	WD mm	14	18	35	44	55	68	94	195	295	390
	Mag	20.00	16.00	10.00	8.00	6.60	5.32	4.00	2.00	1.32	1.00
	FOV 1/2"	0.3	0.4	0.6	0.8	1.0	1.2	1.6	3.2	4.8	6.4
	FOV 1/3"	0.2	0.3	0.5	0.6	0.7	0.9	1.2	2.4	3.6	4.8

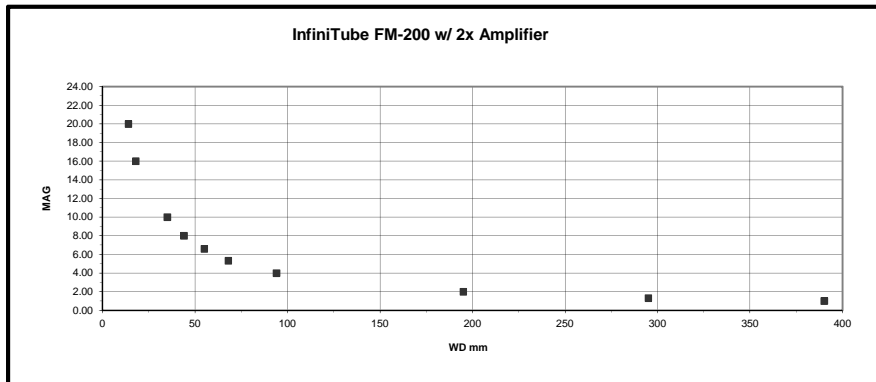
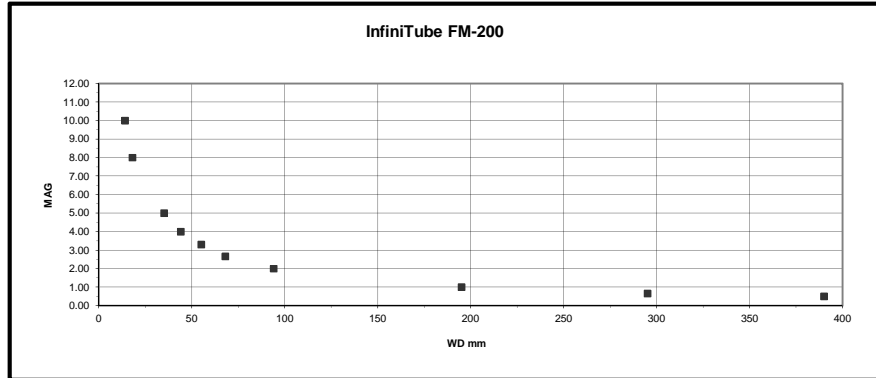

This drawing is for informational purposes only. No other rights or privileges are granted or implied.

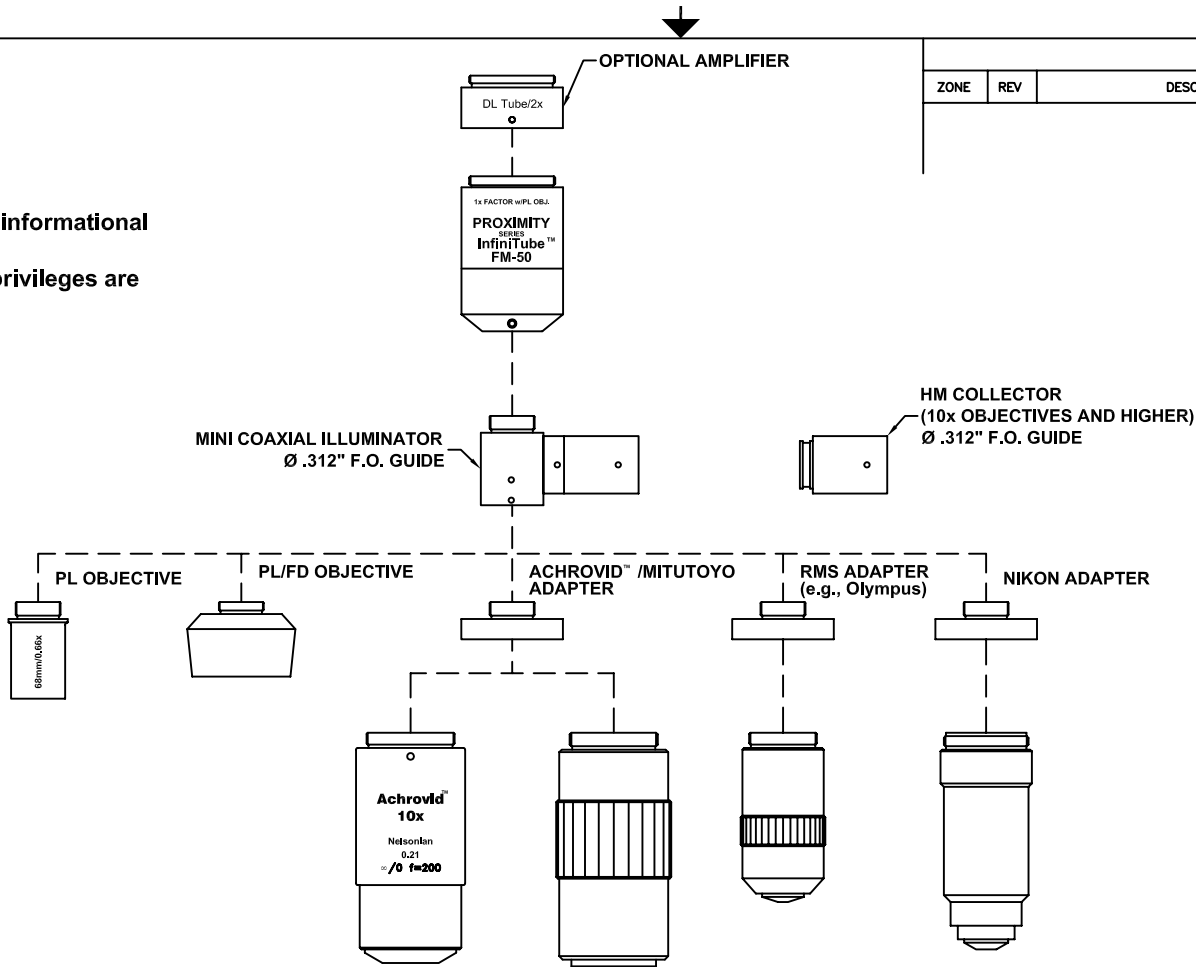

REVISIONS				
ZONE	REV	DESCRIPTION	DATE	APPROVED

ALL DIM ARE mm [inches] AND ARE FOR REFERENCE ONLY AND ARE SUBJECT TO CHANGE.

INFINITY Photo-Optical Company
 2530 Frontier Ave., Boulder, CO 80301
 303/440-4544 Fax 303/440-4144

InfiniTube™ FM-50 SYSTEM

Date: 01/29/08 MB	SIZE B	FSCM NO.	DWG NO. -	REV -
Modified:	SCALE NONE	-	SHEET 1 OF 1	

This drawing is for informational purposes only. No other rights or privileges are granted or implied.

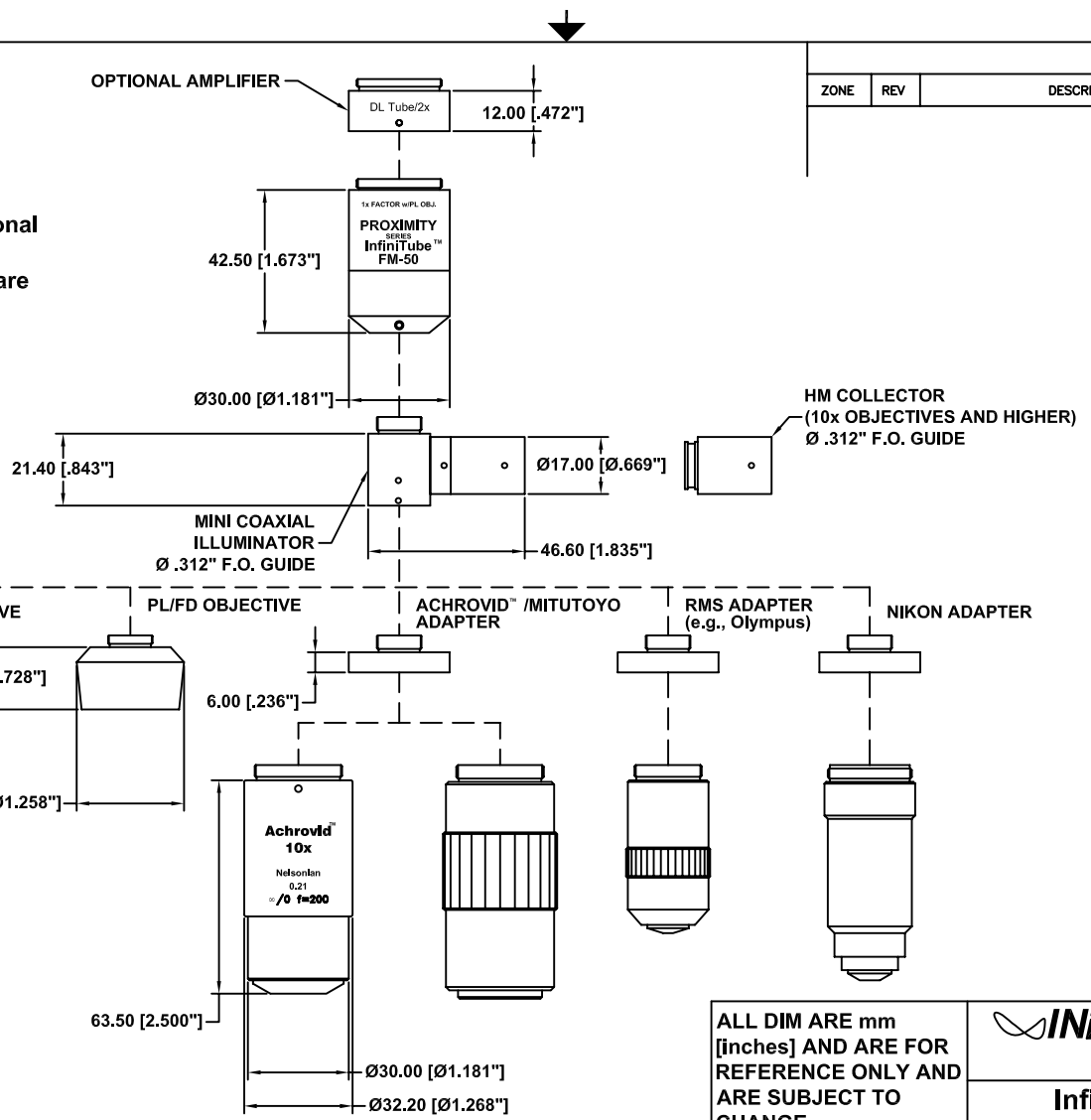

REVISIONS				
ZONE	REV	DESCRIPTION	DATE	APPROVED

ALL DIM ARE mm [inches] AND ARE FOR REFERENCE ONLY AND ARE SUBJECT TO CHANGE.

INFINITY Photo-Optical Company
 2530 Frontier Ave., Boulder, CO 80301
 303/440-4544 Fax 303/440-4144

InfiniTube™ FM-50 SYSTEM DIMENSIONS

Date: 01/29/08 MB	SIZE B	FSCM NO.	DWG NO. -	REV -
Modified:	SCALE NONE	-	SHEET 1 OF 1	

This drawing is for informational purposes only. No other rights or privileges are granted or implied.

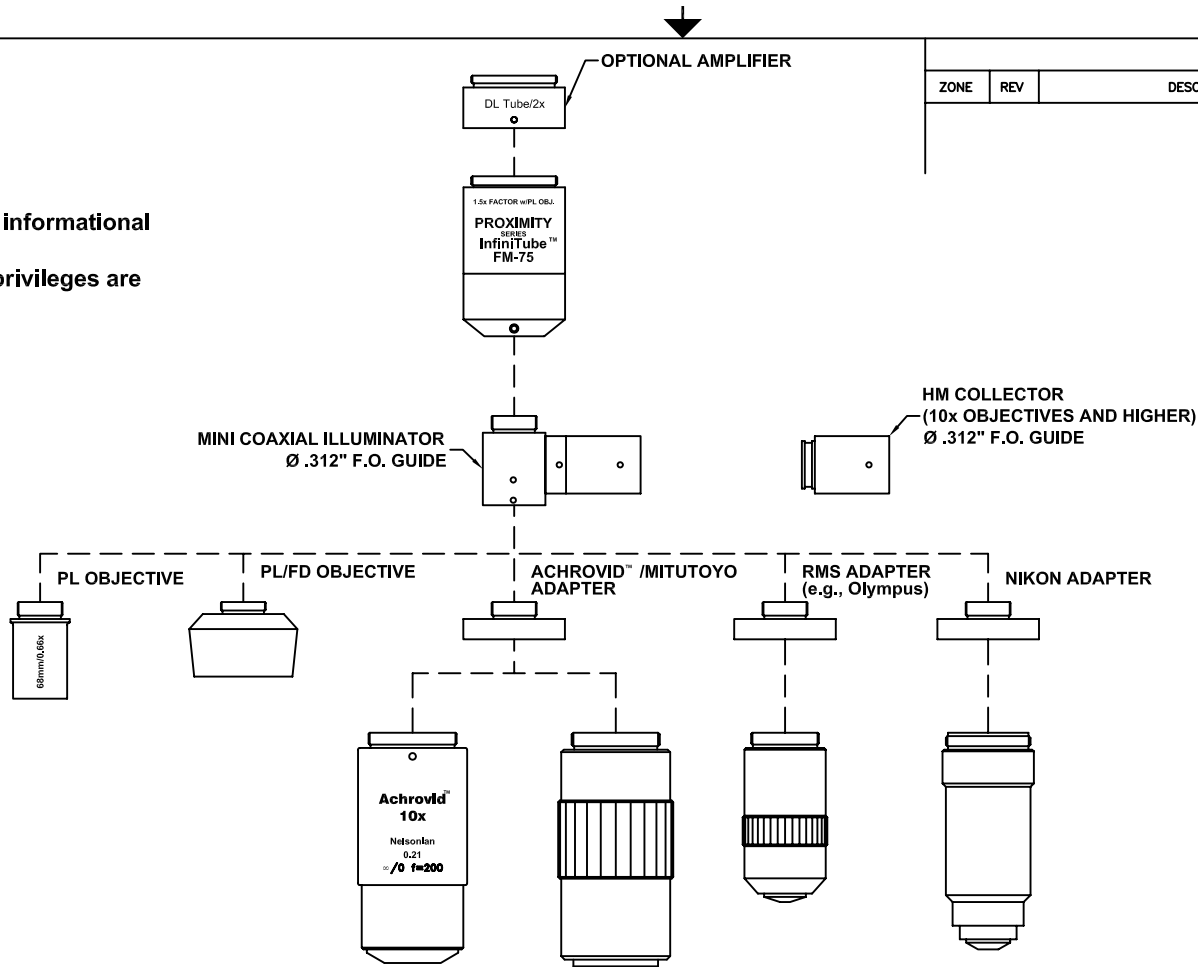

REVISIONS				
ZONE	REV	DESCRIPTION	DATE	APPROVED

ALL DIM ARE mm [inches] AND ARE FOR REFERENCE ONLY AND ARE SUBJECT TO CHANGE.

INFINITY Photo-Optical Company
 2530 Frontier Ave., Boulder, CO 80301
 303/440-4544 Fax 303/440-4144

InfiniTube™ FM-75 SYSTEM

Date: 01/29/08 MB	SIZE B	FSCM NO.	DWG NO. -	REV -
Modified:	SCALE NONE	-	SHEET 1 OF 1	

This drawing is for informational purposes only. No other rights or privileges are granted or implied.

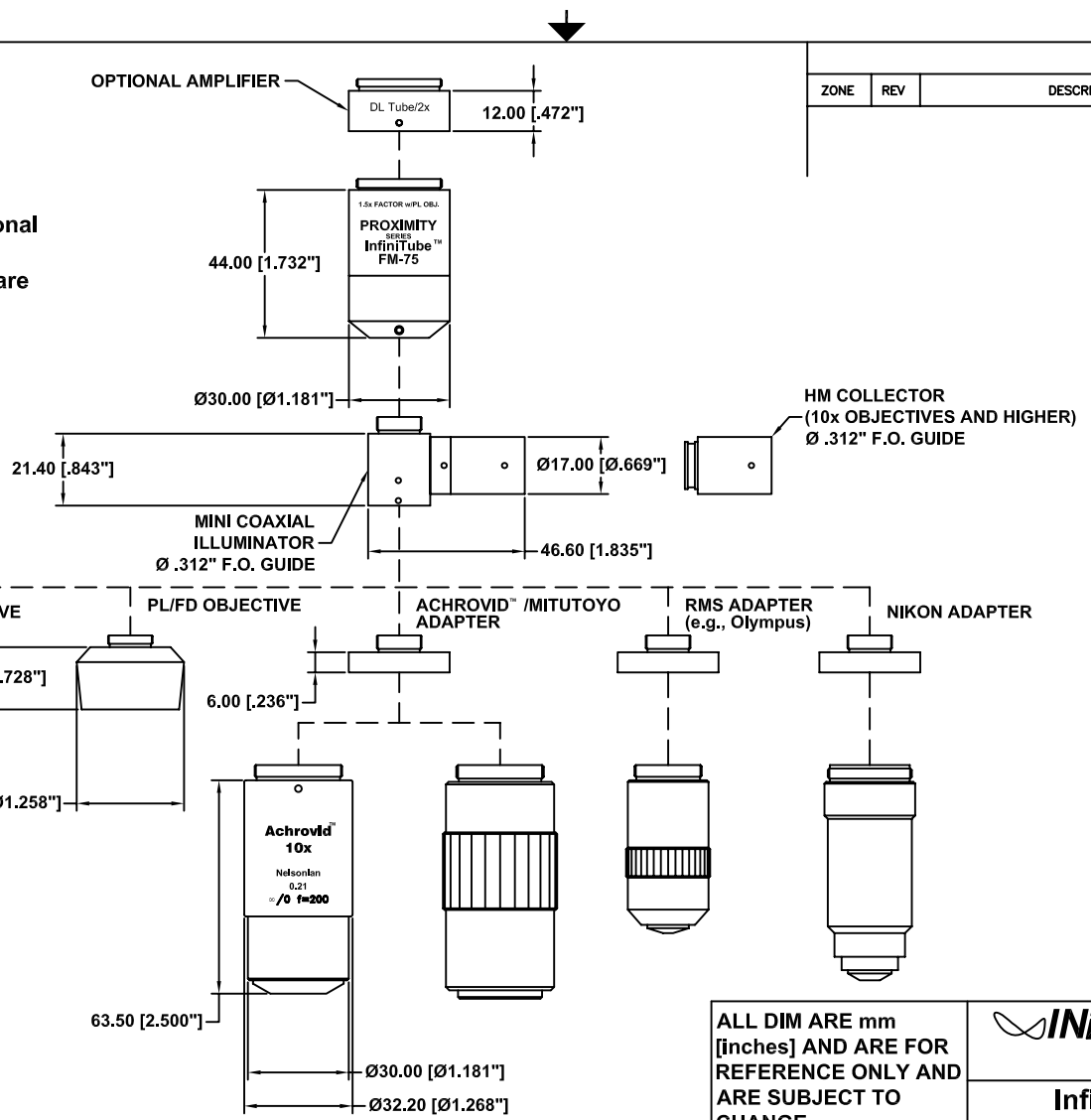

REVISIONS				
ZONE	REV	DESCRIPTION	DATE	APPROVED

ALL DIM ARE mm [inches] AND ARE FOR REFERENCE ONLY AND ARE SUBJECT TO CHANGE.

INFINITY Photo-Optical Company
 2530 Frontier Ave., Boulder, CO 80301
 303/440-4544 Fax 303/440-4144

InfiTube™ FM-75 SYSTEM DIMENSIONS

Date: 01/29/08 MB	SIZE B	FSCM NO.	DWG NO.	REV
Modified:	SCALE NONE	-	SHEET 1 OF 1	-

This drawing is for informational purposes only.
No other rights or privileges are granted or implied.

OPTIONAL AMPLIFIER

REVISIONS

ZONE REV DESCRIPTION DATE APPROVED



FOCUS CONTROL



HM COLLECTOR
(10x OBJECTIVES AND HIGHER)

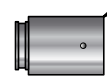

COAXIAL ILLUMINATOR

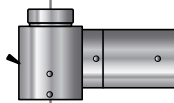

PL OBJECTIVE



PL/FD OBJECTIVE

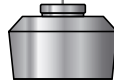

ACHROVID™/MITUTOYO
ADAPTER



RMS ADAPTER
(e.g., Olympus)



NIKON ADAPTER

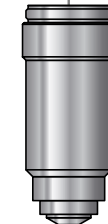
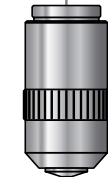

ALL DIM ARE mm
[inches] AND ARE FOR
REFERENCE ONLY AND
ARE SUBJECT TO
CHANGE.

INFINITY Photo-Optical Company
2530 Frontier Ave., Boulder, CO 80301
303/440-4544 Fax 303/440-4144

InfiniTube™ FM-100 SYSTEM

Date: 03/25/04 MB	SIZE B	FSCM NO.	DWG NO. -	REV -
Modified: 05/13/05 MB	SCALE NONE	-	SHEET 1 OF 1	

This drawing is for informational purposes only. No other rights or privileges are granted or implied.

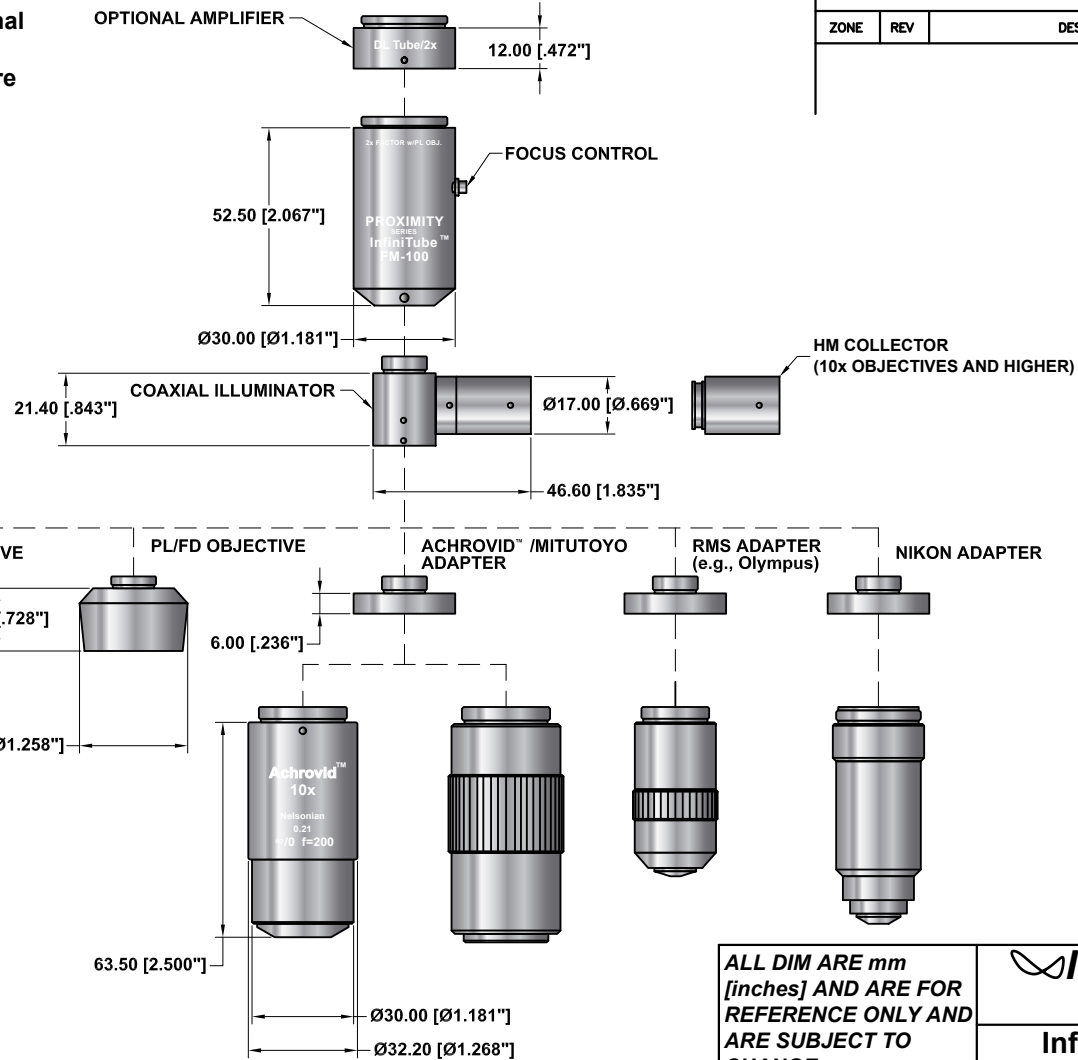

REVISIONS				
ZONE	REV	DESCRIPTION	DATE	APPROVED

ALL DIM ARE mm
[inches] AND ARE FOR
REFERENCE ONLY AND
ARE SUBJECT TO
CHANGE.

INFINITY Photo-Optical Company
2530 Frontier Ave., Boulder, CO 80301
303/440-4544 Fax 303/440-4144

**InfiniTube™ FM-100 SYSTEM
DIMENSIONS**

Date: 03/25/04 MB	SIZE B	FSCM NO.	DWG NO. -	REV A
Modified: 05/13/05 MB	SCALE NONE	-	SHEET 1 OF 1	

This drawing is for informational purposes only. No other rights or privileges are granted or implied.

REVISIONS

ZONE	REV	DESCRIPTION	DATE	APPROVED

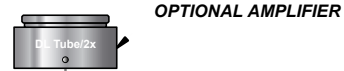

OPTIONAL AMPLIFIER

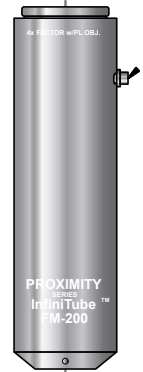

FOCUS CONTROL

HM COLLECTOR
(REPLACES LM COLLECTOR FOR OBJECTIVES 10x AND HIGHER)

LM COLLECTOR

COAXIAL ILLUMINATOR

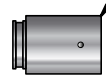
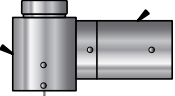

RMS ADAPTER
(e.g., Olympus)

NIKON ADAPTER

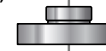
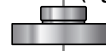

PL OBJECTIVE



PL/FD OBJECTIVE

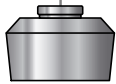

ACHROVID™ /MITUTOYO ADAPTER



ACHROVID™ /MITUTOYO ADAPTER FOR 2x OBJECTIVES

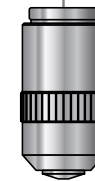
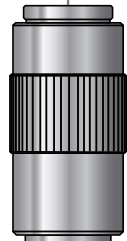

ALL DIM ARE mm [inches] AND ARE FOR REFERENCE ONLY AND ARE SUBJECT TO CHANGE.

INFINITY Photo-Optical Company
2530 Frontier Ave., Boulder, CO 80301
303/440-4544 Fax 303/440-4144

InfiTube™ FM-200 SYSTEM

Date: 03/26/04 MB

SIZE
B

FSCM NO.

DWG NO.

REV

Modified: 07/29/04 MB

SCALE

NONE

-

SHEET

1 OF 1

This drawing is for informational purposes only. No other rights or privileges are granted or implied.

REVISIONS				
ZONE	REV	DESCRIPTION	DATE	APPROVED

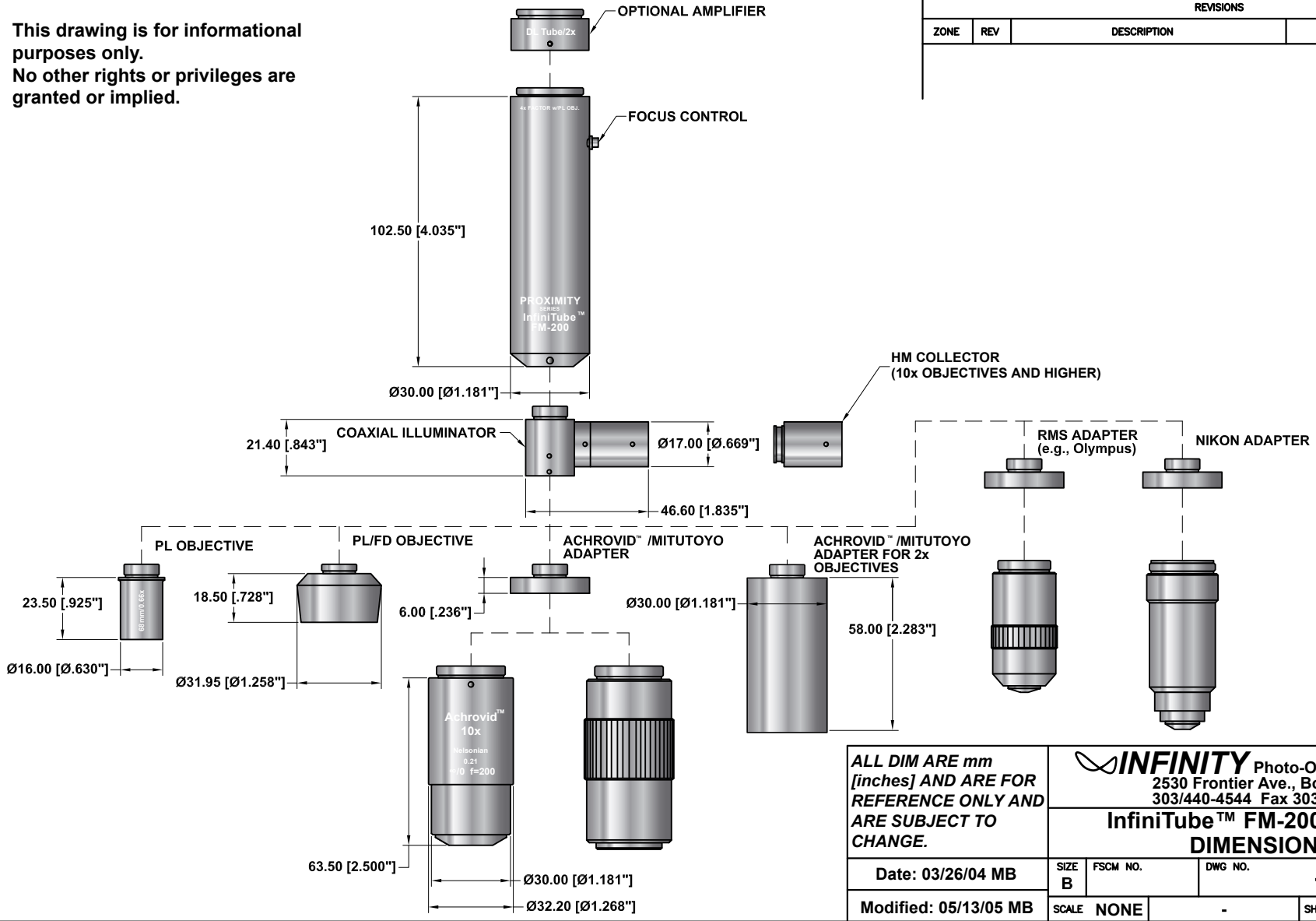

ALL DIM ARE mm [inches] AND ARE FOR REFERENCE ONLY AND ARE SUBJECT TO CHANGE.

INFINITY Photo-Optical Company
 2530 Frontier Ave., Boulder, CO 80301
 303/440-4544 Fax 303/440-4144

InfinitiTube™ FM-200 SYSTEM DIMENSIONS

Date: 03/26/04 MB	SIZE B	FSCM NO.	DWG NO.	-	REV A
Modified: 05/13/05 MB	SCALE NONE	-	SHEET 1 OF 1		

Video Formats

Format	Factor	Diagram
1/4"	0.5	
1/3"	0.75	
1/2"	1.0	
2/3"	1.375	
1"	2.0	

Unless otherwise noted all data is given for 1/2" camera sensors. For FOV or magnification in other sensor sizes use the factors listed. For example, a FOV of 25mm listed for a 1/3" camera would be $25 \times 0.75 = 18.75\text{mm}$.



REVISIONS

ZONE	REV	DESCRIPTION	DATE	APPROVED
------	-----	-------------	------	----------

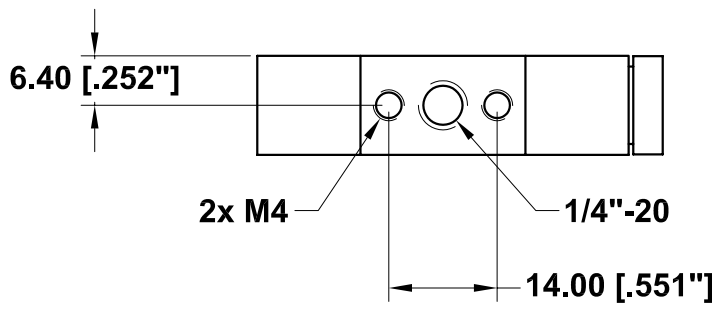
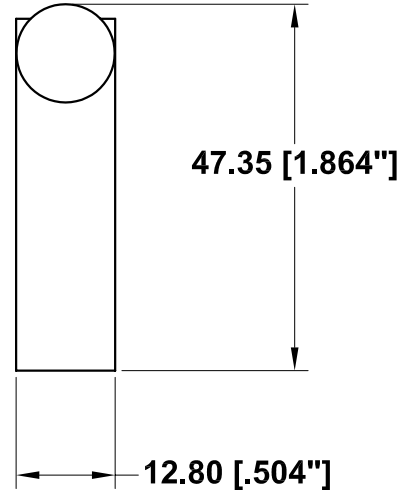
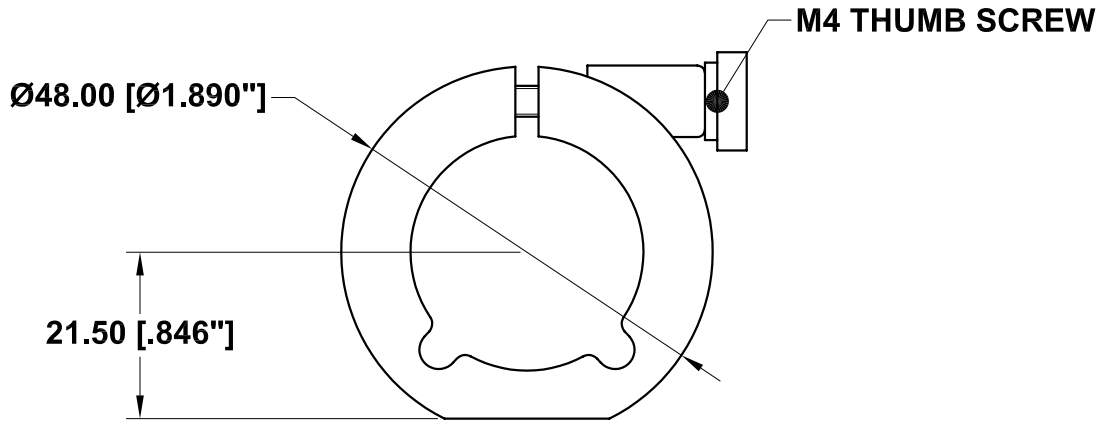

This drawing is for informational purposes only. No other rights or privileges are granted or implied.

ALL DIM ARE mm [inches] AND ARE FOR REFERENCE ONLY AND ARE SUBJECT TO CHANGE.

INFINITY Photo-Optical Company
 2530 Frontier Ave., Boulder, CO 80301
 303/440-4544 Fax 303/440-4144

SMALL MOUNTING CLAMP

Date: 03/19/01 MB
 Modified: 04/06/01 MB

SIZE A	FSCM NO.	DWG NO. 990 170	REV A
SCALE NONE		SHEET 1 of 1	



INFINITY PHOTO-OPTICAL COMPANY LIMITED WARRANTY

INFINITY PHOTO-OPTICAL COMPANY hereby warrants its products to be free from defects in workmanship or materials for the warranty period set forth below. INFINITY PHOTO-OPTICAL COMPANY, at its option, shall repair or replace the defective product without cost to the purchaser, and such repair or replacement shall be the full extent of this express limited warranty. INFINITY PHOTO-OPTICAL COMPANY shall not be liable for any other damages either direct or consequential.

This warranty is made to the original purchaser, and is effective only on new equipment purchased from INFINITY PHOTO-OPTICAL COMPANY, or a dealer authorized by INFINITY PHOTO-OPTICAL COMPANY to sell the product.

This warranty is valid only when the product is returned to the authorized dealer from whom it was purchased, or returned directly to INFINITY PHOTO-OPTICAL COMPANY, freight prepaid, with proof of date of purchase.

This warranty does not extend to any defect, malfunction or failure caused by misuse, abuse or the use of the product with equipment for which it may not have been intended. Any unauthorized repair voids this warranty.

The warranty period for all products manufactured by INFINITY PHOTO-OPTICAL COMPANY is five (5) years from date of original purchase. Parts or components made or sourced from other manufacturers shall be solely covered by that manufacturer's warranty.

The warranty contained herein is the only warranty made by INFINITY PHOTO-OPTICAL COMPANY. Any implied warranty of merchantability and/or fitness for a particular purpose is expressly excluded from this warranty. INFINITY PHOTO-OPTICAL COMPANY shall not be liable for any expense, loss, incidental or consequential damages which may arise in connection with the use of this equipment. Recovery under this warranty is limited to repair or replacement of the equipment as provided above.

INFINITY PHOTO-OPTICAL COMPANY reserves the right to modify designs, equipment and accessories without notice.